

## Door Phone IPDP

*IPDP – 00*  
*IPDP – 00C*  
*IPNC1 - mod*  
*IPNC2 - mod*

*IPNC4 - mod*  
*NC - mod4*  
*NM - mod4*  
*IPDP-K*



**User manual**



## **Welcome**

We congratulate you on purchase of “**DoorPhone VoIP**” (VoIP = Voice over IP), which is the improved version of successful “New DoorPhone” (NUDV). This DoorPhone VoIP will widely manage to satisfy your needs of communication with persons at the building front door or your company entry, or family house doorway. The universality lies in possibility to connect this guard to an Ethernet network or VoIP exchange or directly to SIP server through internet connection.

The basic DoorPhone VoIP module (**IPDP-00**) is supplied without button. The next version of basic VoIP module (**IPDP-00C**) is with integrated colour camera. The buttons modules are connected to basic module (**IPDP-00 or IPDP-00C**) and they are manufactured with 1, 2 or 4 buttons with Ethernet connection (**IPNC1-mod, IPNC2-mod, IPNC4-mod**). Further the whole system allows to be enlarged by NC-mod4 and NM-mod4 modules up to 64 buttons using the basic mechanical MK1...MK4 units. The whole assembly can be completed with cover frame or rain-protective case for flash or surface instalation. The last optional module is Keypad (**IPDP-K**).

The Doorphone is supplied from AC/DC powersupply 12V. The basic features include the possibility to open up to two doors by means of connected electrical locks (the first 10 buttons can be used for door code opening) and easier programming by WEB sites from PC by network connection.

# Table of Contents

- DOORPHONE VOIP ..... 1**
- 1 BASIC DESCRIPTION..... 4**
  - 1.1 FEATURES ..... 4
  - 1.2 MODULE ASSEMBLY ..... 5
  - 1.3 MODULE FEATURES ..... 6
    - 1.3.1 *IPDP Basic Module* ..... 6
    - 1.3.2 *Extending Module IPNCx-mod, NC-mod4 and NM-mod4*..... 9
    - 1.3.3 *IPDP-K Keyboard Module* ..... 10
  - 1.4 INSTALLATION OF DOORPHONE VOIP ASSEMBLY ..... 11
    - 1.4.1 *Installation on Plaster*..... 11
    - 1.4.2 *Flush-Mounted Installation* ..... 11
  - 1.5 CHANGE OF NAMEPLATES ..... 11
  - 1.6 FOCUS CAMERA AND DESCRIPTION OF FRONT PANEL ..... 13
- 2 DOORPHONE VOIP OPERATION ..... 14**
  - 2.1 SIGNALING OVERVIEW..... 14
  - 2.2 VISITOR AT DOOR ..... 14
    - 2.2.1 *DoorPhone without Keyboard*..... 14
    - 2.2.2 *DoorPhone with Keyboard*..... 15
  - 2.3 PERSON INSIDE OBJECT ..... 16
    - 2.3.1 *Outgoing Call* ..... 16
    - 2.3.2 *Incoming Call* ..... 16
- 3 PROGRAMMING OF PARAMETERS..... 17**
  - 3.1 BASIC VOIP SETTINGS ..... 17
    - 3.1.1 *Choosing a mode and login* ..... 17
    - 3.1.2 *Language option* ..... 18
    - 3.1.3 *Network settings*..... 18
    - 3.1.4 *Peer to peer or SIP server connection* ..... 20
    - 3.1.5 *Audio codec setting*..... 20
    - 3.1.6 *Setting video*..... 21
    - 3.1.7 *Service settings* ..... 22
  - 3.2 SETTING DOORPHONE PARAMETERS ..... 23
    - 3.2.1 *Basic Parameters* ..... 23
    - 3.2.2 *All about relays*..... 24
    - 3.2.3 *Time Parameters*..... 26
    - 3.2.4 *Direct Dialing – Memories* ..... 27
- 4 TECHNICAL PARAMETERS..... 28**
  - 4.1 ELECTRICAL PARAMETERS ..... 28
  - 4.2 MECHANICAL DIMENSIONS ..... 28

# 1 **Basic Description**

---

## 1.1 **Features**

- Modular system allows to connect 4 to 64 buttons
- Voice communication is supplied only from telephone line
- Two 16digit numbers (IP address) with each button
- Day/night switching
- Possibility of the call extension by \* or # choice
- Possible to connect two independent locks for door opening
- Possible use of 5 switch modes (e.g. camera, lighting, gradual opening)
- Two codes for hanging up the guard from telephone
- Two codes for door opening from telephone
- Six code locks (password from buttons at the door)
- Possibility to connect a numerical keyboard this way that the guard can include 4 – 18 standard buttons
- Integrated heating of printed circuit
- Permanent lighting through visiting cards
- Included color camera
- Ethernet – 10/100Mb with standard 10BaseT a 100BaseTx
- Web server for remote configuration – BOA
- Power supply 12V AC/DC, 500mA
- Operating system – Linux 2.6
- USB for connection camera – USB guest 1.1, software GSPCA software for video transmission to the browsers in PC – W3CAM(J-PEG, RTSP Stream)
- SIP connection P2P or PBX network system
- WEB – firmware upgradeable
- WEB – interface for control and setup parameter

## 1.2 Module Assembly

The IPDP structural elements are the basic modules with color camera IPDP-00C or without camera IPDP-00 and extending button modules IPNC1-mod with one button, IPNC2-mod with two buttons, IPNC4-mod, NC-mod4 and NM-mod4 with four buttons. Further it is possible to provide the assembly with numerical keyboard. The complete assembly consists similarly to IPDP system of max. 4 modules in column and max. 3 columns side by side.



IPDP-00



IPDP-00C



IPNC1-mod



IPNC2-mod



IPNC4-mod



NC-mod4



NM-mod4



IPDP-K



MK-2



Fixing  
frame 2



Flanging frame2  
(flush-mounted)



Canopy2  
protective cover  
(flush-mounted)



KPD2-rain  
(on plaster)

By flush-mounted assembly the MK-1 to MK-4 boxes are used as well as with UDV system.

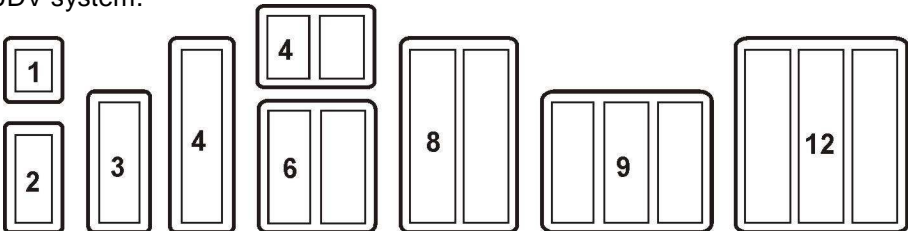

Examples of frame configuration

# 1.3 Module Features

## 1.3.1 IPDP Basic Module

The IPDP basic module assembling from modulus IP and motherboard. Positioning setting elements and connectors is on picture 1.

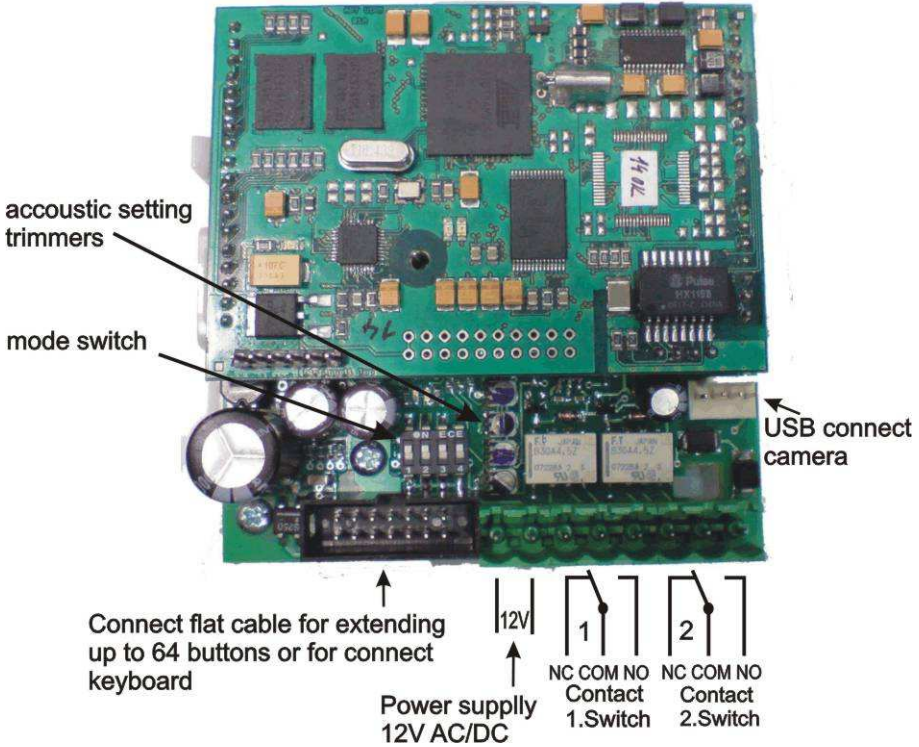

**Picture 1 Basic module - motherboard**

The “14 pin black connector” serves the connection of extending modules by means of flat cable.

The “USB” serves the connection internal color camera

For IPDP is necessary used the AC voltage of min. 10Vst - max. 15Vst or DC voltage of min. 12Vss to max. 18Vss must be energized to “12V” terminal. This source loading depends on number of modules, since it simultaneously serves feeding of lighting through visiting cards – at max. number of connected modules the demand will not exceed 300mA. This source can be also used for feeding of lock(s), and then it is necessary to consider the electrical lock demand. In practice the alternating feeder 12V/1A mostly meets these demands.

The connection of relay contact terminals is shown on fig. 1. The “NO” designation means an idle-disconnected contact, “COM” means a pin contact (middle) and “NC” means an idle-connected contact. The contacts of both switches are galvanically isolated each other and from other guard circuits. The variants of connection are shown on picture. 2.

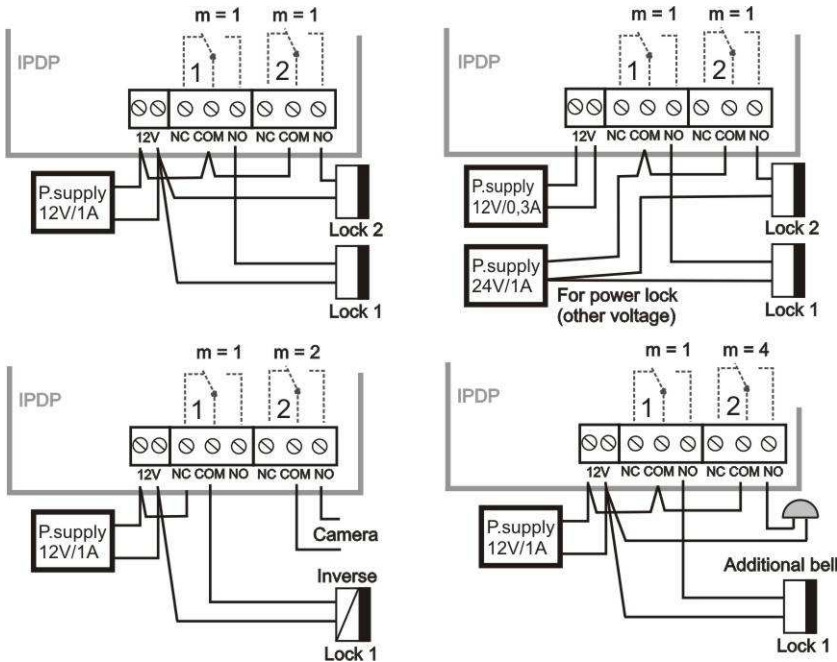

**Picture 2 Examples of relays connections**

**Setting voice communication** – position trimmers are presetting from manufacture and in majority case agree with, therefore changes setting altering only in necessary case. Basic position of trimmers, sense of rotation and meaning trimmers are illustration on picture 3.



**Picture 3 Setting of trimmers**

**DIP switch** setting basic operation and default setting. See on picture 4.

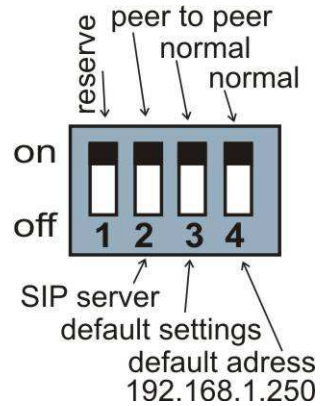

**Picture 4 DIP switch settings**



### 1.3.2 Extending Module IPNCx-mod, NC-mod4 and NM-mod4

This module is supplied in three designs. The **IPNCx-mod** module (picture 6) has four buttons and includes the electronics to be connected to the basic module. The **NC-mod4** module has four buttons and includes the electronics to be connected to the IPNCx-mod or to previous NC-mod4 module. This module is only connected by flat cable – buttons and lighting through is already interconnected. The terminals for connection of other four buttons and current supply of lighting are further placed on module (on following NM-mod4). The **NM-mod4** module is always connected to previous IPNCx-mod or NC-mod4. The connection is not prepared and should be done by conductors – see on picture 5.

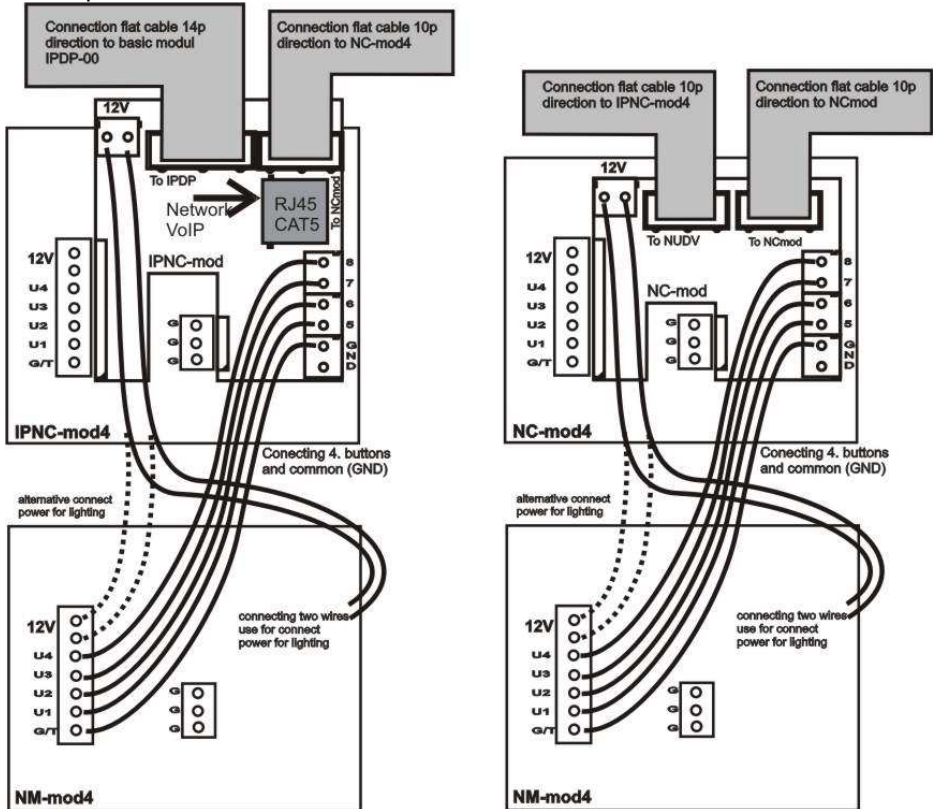

Picture 5 Connection of (IP)NC-mod4 and NM-mod4

The **flat cable connection** is facilitated by connector locks, preventing from rotation, but to keep the connection routing is imperative.

“To IP DoorPhone” is always the routing to the basic module.

“To NCmod” is routing to the row end (on last NC-mod.).

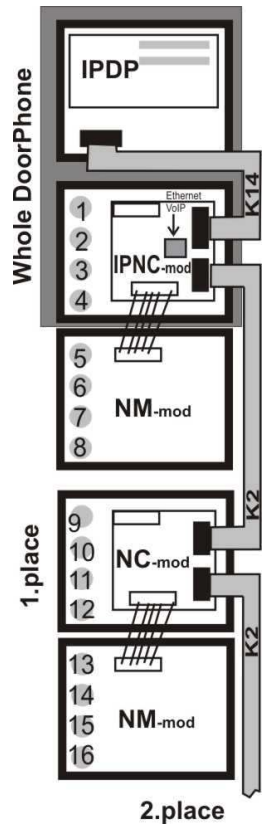
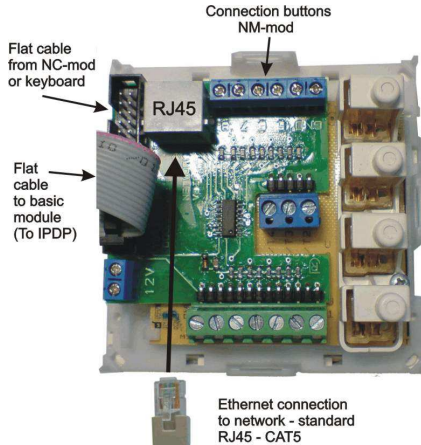

**Picture 6 IPNC4-mod module**

### 1.3.3 IPDP-K Keyboard Module

The keyboard module is only connected by flat cable as well as NC-mod4 module. The only difference is that keyboard module is always the last in row (no other module can be connected behind it). Connect on the first place (to output of the IPNCx-mod) or the second (to output of the first NC-mod4) positions or third place. It means that 4 to 24 buttons with direct dialing can be used instead of keyboard (per assembly). The most frequent used assemblies are:

IPDP-00 + IPNCx-mod + IPDP-K

IPDP-00 + IPNCx-mod + NM-mod4 + IPDP-K

IPDP-00 + IPNCx-mod + NM-mod4 + NC-mod4 + IPDP-K

IPDP-00 + IPNCx-mod + NM-mod4 + NC-mod4 + NM-mod4 + IPDP-K

Pay attention when programming – the position of keyboard connected must be correctly specified.

The choice is entered by gradual pressing of buttons with digits. Firstly the key symbol must be pressed to enter a password. When pressing **X**, the DoorPhone will hang up or cancel your dial. Button with key symbol use for “Point” in IP adress in P2P mode.

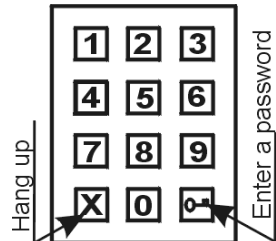

## 1.4 Installation of DoorPhone VoIP Assembly

### 1.4.1 Installation on Plaster

By installation on plaster the only compact box - Rain-Protective Cover KPDxx is used, which will supersede all mechanical parts (MKxx, Canopy xx and Fixing Frame xx). The installation is made by screwing to the wall by means of dowels. See KPD1 on figure.



### 1.4.2 Flush-Mounted Installation

The MKxx mounting box is built-in wall. Be careful in orientation of assembling holes when nearly MK1 square box is used – it must be in vertical axis. The well-embedded box is shown on figure.

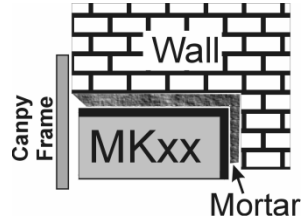

The Protecting Frame (provides overlapping of unevenness after mounting box walling-in) and Canopy (necessary for installation in external areas) form other accessories for flush-mounted installation. When installed in surroundings with possible water condensation (temperature changes) or water spraying (rain) it is recommended to connect the jumper on basic module – heating ON.

The **board heating** has two positive functions partly it heats up the electronics in winter at temperatures below  $-20^{\circ}\text{C}$  (most details with extended temperature range has guaranteed parameters from  $-20^{\circ}\text{C}$ ) and partly with external installation at swift temperature changes and higher air humidity by switched heating no water condensation occurs on basic guard board, which assures its reliable function.

## 1.5 Change of nameplates

The first step is **dismantling of a fixing frame** from module, where we want to change a nameplate. It can be executed by unscrewing of two screws under plastic covers on fixing frame. When removing the fixing frame we can see two independent modules. The **front part** (metallic) of the button module has to be first separated from plastic part in this way that we will put off the **plastic lug**, ensuring the front part on the right side. Each button has its separate nameplate hold by means of plastic flag (see figure). The paper nameplates can be printed from Excel form.

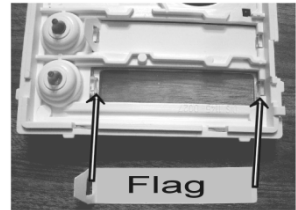
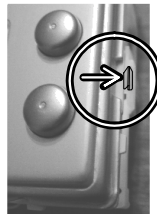

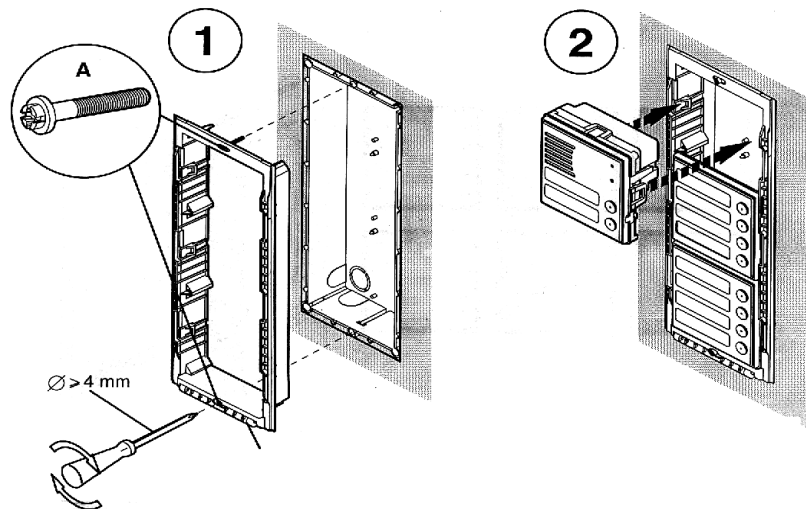
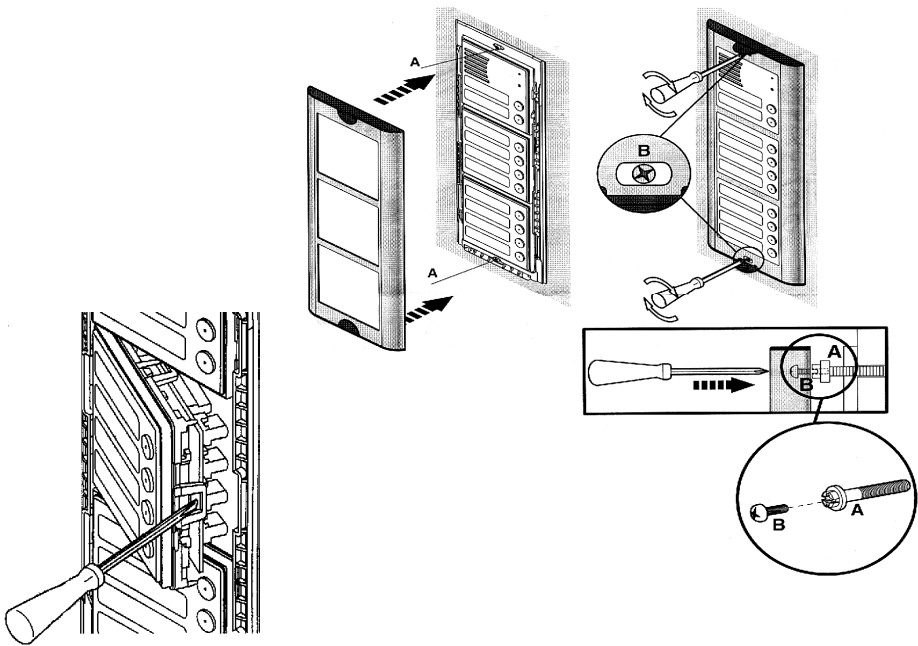

**Picture 7 Mechanical assembly parts**

## 1.6 Focus camera and description of front panel

If is need focus picture from camera, so everything is illustration on picture front panel basic module on Picture 8 .









**Picture 8 front panel of basic module IPDP**

1. front panel
2. microphone
3. indication LED
4. turning with objective of camera is focus picture
5. camera
6. press on this tongue in direction arrow is unfix front panel

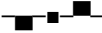
## 2 DoorPhone VoIP Operation

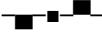
### 2.1 Signaling Overview

The all-purpose guard signals an acoustic conditions they may occur during operation. Another signaling can be done by means of red LED (placed under microphone hole). You can listen the signaling samples in Nset setting program.

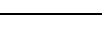
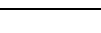
Condition	Tones	Tone frequency	LED
Line lifting up		425-850-1275	glows
Line hanging up		1275-850-425	goes out
Report after calling		425-850-1275	glows
Notice about call end		1275	glows
Parameter confirmation			glows
Switch on (Reset)		1275-850-1275	blinks
Error (anything, if unsuitable)		425....	
Empty memory (no progr. numb.)		850-1275-1700...	

### 2.2 Visitor at Door

The all-purpose guard function is influenced partly by used guard assembly (with keyboard or without it) and partly by setting of guard parameters.

#### 2.2.1 DoorPhone without Keyboard

The DoorPhone **buttons** are provided by nameplates or positions of persons inside the object. The incoming person will press the corresponding button, the DoorPhone will lift up the VoIP canale neither immediately (the button is not the first number from code lock), or with delay and dial the programmed phone number thru VoIP, but dial number differs by choice mode, which is set in the DoorPhone :

- **Day/night mode** = being the DoorPhone in Day mode, so it is always dialing a number set in table 1, in Night mode, it is always dialing a number set in table 2.
- mode **two number group** = first press – it always dials a number set in table 1. By repeated press of the same button or detection of busy tone after dialing the DoorPhone will select the number from the second group (*table 2*). The next press of the same button again selects a number of the first group, etc.....

The switch (**code lock**) can be controlled by first 10 buttons of DoorPhone. If the visitor at door presses buttons in such combination that meet the

preprogrammed code and the time among presses is not bigger than the set point, then the DoorPhone will pick up and close the corresponding switch (if set in m=1 or m=5 modes) to the period given by setting in parameters. Then it will hang up.

### 2.2.2 DoorPhone with Keyboard

The DoorPhone with keyboard can also include besides the keyboard up to 16 buttons of direct dialing always behaving as to be mentioned in chapter 1.3.3 (page 10) except the code lock. This one is always situated on keyboard. After keyboard is connected, the position, where the keyboard is connected to, should be set in programming parameter.

The keyboard has two functional buttons – **key symbol** = once pressing the numerical combination is considered as the combination for control of the switches. The second button – **X symbol** = when pressing the DoorPhone immediately will hang up.

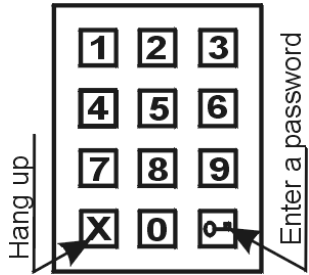

The number selection on keyboard can be executed in two ways:

- The incoming person is dialing number as to be done on phone – the period among button presses should be lower than the value given by programming *parameter*. After this period the DoorPhone will lift up and dial the given number.
- On buttons the incoming person is dialing a two-digit number (from 01 to 64), which represents the memory number, where the 16-digit number is stored (same as for buttons). The number dialing is managed by Day/Night setting or mode for two groups of numbers (as described in chapter 2.2.1 page 14).

## 2.3 Person Inside Object

The person inside object is considered a person that is in phone contact with DoorPhone.

### 2.3.1 Outgoing Call

The outgoing call is the call from DoorPhone (caused by visitor). After guard choice the telephone is ringing inside object and the pick up will allow speaking to the visitor at door. The code choice can close the switch, if set to m=1 or m=5 modes, change over the Day/Night modes and hang up the DoorPhone. The DoorPhone in 10 seconds before call end will send a notice about call end and the call may be extended by sign selection (\* or #). The telephone hanging up will end the call.

### 2.3.2 Incoming Call

The incoming call is the call to the DoorPhone (caused by person inside object). After exchange number selection, where the DoorPhone is connected, the DoorPhone is ringing and when set number of rings is over, the DoorPhone will pick up and it is possible to speak. The possibilities are the same as with outgoing call.



Тел: +7 495 7907870  
Моб: +7 965 4429948  
Skype: Discoverytelecom  
Mail: [info@discoverytelecom.ru](mailto:info@discoverytelecom.ru)  
[www.discoverytelecom.ru](http://www.discoverytelecom.ru)



# 3 Programming of Parameters

## 3.1 Basic VoIP settings

### 3.1.1 Choosing a mode and login

It is important to choose a DoorPhone mode first. The DoorPhone can work in the PeerToPeer mode or SIP server mode. The mode setting can be made by a relevant switch (DIP switch see on picture 8). In the SIP server mode is possible to choose SIP server (external). It can be set in a configuration interface of the DoorPhone.

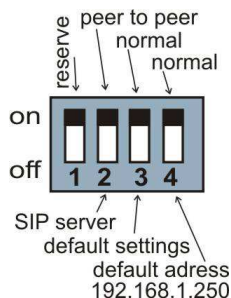

Picture 9 DIP switch setting

In your web browser enter IP address of the DoorPhone, default is 192.168.1.250. See Picture 10. Enter user name and password. User name is „admin“, default password is „1234“. See Picture 10.



Picture 10 First site - video from camera



Picture 11 Login to setup

### 3.1.2 Language option

Language setting can be made in a menu on the left panel.

The screenshot shows the 'Network setting' configuration page. On the left, the 'Menu:' section lists various settings, with 'Language:' below it. A dropdown menu is open for 'Language', showing 'english' selected and 'čeština' as an option. A red checkmark is next to the 'Set' button. The main 'Network setting:' area contains fields for 'Setup via DHCP' (unchecked), 'DHCP client ID' (udy\_guard), 'IP address' (192.168.1.250), 'Network mask' (255.255.0.0), 'Default gateway', 'Primary DNS server', and 'Secondary DNS server'. At the bottom are 'default values' and 'save and restart' buttons.

### 3.1.3 Network settings

Network settings are located in the **Network setting** menu item. It is possible to use DHCP service (1) or you can enter IP addresses manually.

**Manual configuration:**

This screenshot is similar to the previous one but highlights manual configuration. In the 'Menu:' section, 'Network setting' is selected with a red checkmark. In the 'Network setting:' area, the 'Setup via DHCP' checkbox is circled with a red '1'. The 'IP address' and 'Network mask' fields are also circled with red checkmarks. The 'save and restart' button is circled with a red '2'.

After making changes click on a **save and restart** button.

1 –Enable/disable ethernet settings via DHCP

2 –Default value – presettings to the firm settings. After making changes click on a save and restart button (display screen - see page 22).

## DHCP configuration:

**Menu:** Day mode

- Network setting ✓ (4)
- Basic parameters
- Setting audio
- Setting video
- Relays
- Time parameters
- Memory numbers
- Service
- Video ← (5)

**Language:**

english [v] [Set]

**Network setting:**

Setup via DHCP:  (1)

DHCP client ID:  ✓

IP address:

Network mask:  (2)

Default gateway:

Primary DNS server:

Secondary DNS server:

(3)

After making changes click on a **save and restart** button.

- 1 –Enable/disable ethernet settings via DHCP
- 2 –show automatic DHCP generate IP address and other settings
- 3 –Default value – presets to the firm settings. After making changes click on a save and restart button (display screen - see page 22).
- 4 –Show mode of DoorPhone – Day/Night
- 5 –Return to the video from color camera screen

**Important:** if you use setup via DHCP, then it's assigning IP address to DoorPhone automatically and network administrator must tell you actual address, to was possibility display video in web browser. Because assigning IP adress can change after e.g . failure power supply in object, so they recommended enjoy DoorPhone with fixed IP address.

### 3.1.4 Peer to peer or SIP server connection

The DoorPhone can be set to the peer to peer (P2P) mode or to the SIP server mode by DIP switch (page 17). In P2P mode DoorPhone calling IP address – in memory buttons (page 27).

If you setting SIP server mode by DIP switch, so add in menu item SIP parameters

Day mode

**SIP parameters:**

**Menu:**

- Network setting
- Basic parameters
- SIP parameters ✓
- Setting audio
- Setting video
- Relays
- Time parameters
- Memory numbers
- Service
- Video

Language: english Set

SIP proxy server Address:  ①

Port: 5060 ①

Account module Name:  ②

Password:  ③

default values save changes

After making changes use the **save changes** button.

1 –SIP proxy server IP address or the SIP server name and port (usually 5060 or 5061)

2 –Registering data to SIP proxy server

3 –Default value – presetings to the firm settings. After making changes use the save changes button.

### 3.1.5 Audio codec setting

Day mode

**Setting audio:**

**Menu:**

- Network setting
- Basic parameters
- Setting audio ✓
- Setting video
- Relays
- Time parameters
- Memory numbers
- Service
- Video

Language: english Set

Priority 1: G711µ ①

Priority 2: G711a

Priority 3: G726-32bit

Priority 4: GSM

default values save changes ②

After making changes use the **save changes** button.

1 –There is choosing only priority using audio codecs, used codec is selection automatically at make audio connection in SIP protocol.

2 –Default value – presetings to the firm settings. After making changes use the save changes button.

### 3.1.6 Setting video

Day mode

**Menu:**

- Network setting
- Basic parameters
- Setting audio
- **Setting video** ✓
- Relays
- Time parameters
- Memory numbers
- Service
- Video

**Language:**

english

**Setting video:**

Image size: 320 x 240 ①

Numbers image per sec.: 5 ②

Brightness: 50 ③

Colour: 0

Contrast: 50

Hue: 0

Auto brightness: Auto

Quality: 4

Whiteness: 0

Light frequency: 60 ④

After making changes use the **save changes** button.

1 –Resolution display video

2 –Number picture per second (frequency restoring picture)

3 –Setting next parameters of camera

4 –Default value – presetings to the firm settings. After making changes use the save changes button.

### 3.1.7 Service settings

- 1 –display current version of firmware in module VoIP and in module doorphone, button switching if is has save history events in basic or enhanced mode - it is important to analyses mistakes and problems. This file it is possible save to PC by click on download log file.
- 2 –tool for upgrade firmware in module VoIP and in module doorphone, switching automatic - information is in upload fille. Firmware upgrade use for file with new style designed too – color,fonts, logo (picture max 200pxl)
- 3 –Addition / change language file - upload fille with language assignment
- 4 –change access password, default is 1234
- 5 –reboot VoIP module.

## 3.2 Setting DoorPhone parameters

### 3.2.1 Basic Parameters

<b>Menu:</b> <ul style="list-style-type: none"><li>• Network setting</li><li>• Basic parameters ✓</li><li>• Setting audio</li><li>• Setting video</li><li>• Relays</li><li>• Time parameters</li><li>• Memory numbers</li><li>• Service</li><li>• Video</li></ul> <b>Language:</b> english <input type="button" value="Set"/>	<b>Day mode</b> <b>Basic parameters:</b> <b>Mode of choice numbers:</b> <input checked="" type="radio"/> Day-Night ① <input type="radio"/> 2 group of numbers <b>Hang up phone:</b> ③ Code for hang up phone 1: <input type="text" value="55"/> Code for hang up phone 2: <input type="text" value="66"/> <b>Switching between Day Night:</b> <input checked="" type="radio"/> Manually <input type="radio"/> Automatic Keyboard to position: <input type="text" value="0"/> ⑥ <input type="button" value="default values"/> ⑦ <input type="button" value="save changes"/>	<b>Prolongation char:</b> <input checked="" type="radio"/> * - asterisk ② <input type="radio"/> # - grid <b>Code of switching:</b> ④ Code for switching Day: <input type="text" value="11"/> Code for switching Night: <input type="text" value="10"/> <b>Mode of keyboard:</b> ⑤ <input checked="" type="radio"/> Direct choice number (phone) <input type="radio"/> Choice of number from memory
--	--	--

After making changes use the **save changes** button.

- 1 – Mode of DoorPhone choice selects number per **Day/Night** DoorPhone mode or selects numbers of the first and second groups.
- 2 – Sign for call extension \* or # (10sec before call end the DoorPhone will send a notice, then the call may be extended)
- 3 – Two commands in order to hang up the DoorPhone using both switches [2 digits]. The advantage is to set the same command both for switch closing and command to guard hanging up (page 24).
- 4 – Command for **DAY / NIGHT** mode switching  
**Note:** The switchover to Day/Night mode remains set in guard even after power supply disconnection.
- 5 – Dialing as on normal telephone (all number of called person should be pressed on keyboard) - recommended for use **SIP proxy server**.  
Only 2-digit memory number is entered on keyboard by which the number of called person is stored (memory number corresponds to button number with respect to Day/Night switchover) - recommended for use P2P.
- 6 – =0 only NC-mode connected to the basic module  
=1 the keyboard connected on the first position (after IPNCx-mod)  
=2 the keyboard connected on the second position (after first NC-mod4)  
=3 the keyboard connected on the third position (after second NC-mod4)  
explanation of position keyboard is on chapter 1.3.2 (page 9)
- 7 – Default value – presets to the firm settings. After making changes use the save changes button.

**ATTENTION!** This parameters setting will sharply influence whole DoorPhone function.

## 3.2.2 All about relays

Day mode

**Menu:**

- Network setting
- Basic parameters
- Setting audio
- Setting video
- Relays ✓
- Time parameters
- Memory numbers
- Service
- Video

Language:

english

**Relays:**

Relay 1:

Relay mode:  ①

External code day + night:  ②

External code day:

External code night:

Internal code from phone:  ③

Relay closing [sec]:  ④

Control of incoming call:  ⑤

Relay 2:

Relay mode:

External code day + night:

External code day:

External code night:

Internal code from phone:

Relay closing [sec]:

Control of incoming call:

Delay between 1 and 2 in mode 5:  ⑥

⑦

After making changes use the **save changes** button.

1 – Relay mode:

- =1 **switch** mode – it will close on command or password for period **t1/2** (used for electrical locks, gate opening etc.)
- =2 **camera** mode – it will close by guard pick up and open by hanging up.
- =3 **lighting** mode – it will close by guard pick up and stay closed even for period **t1/2** after guard hanging up.
- =4 **bell** mode – it will close after button pressing and open after period **t1/2** (used for e.g. external bell or horn connections).
- =5 **gradual opening** mode – in this mode the only relay 2 will be set together with relay 1 set to mode 1. The relay 1 is activated for period **t1**, then the time **t3** is proceeding before relay 2 closing. Then the relay 2 is activated for **t2** period and afterwards the DoorPhone hangs up.

**Note:** The only relay 1 can be activated from phone and all sequence started. Besides that the relay 2 can be separately activated from buttons by password.



- 2 –password for relay closing from buttons or keyboard [2 to 6 digits]. Total 6 passwords, they are controlled by Day/Night; the combination is entered either by DoorPhone buttons (first 10 buttons) or from attached keyboard (after pressing of key symbol). The relay closing influences the set switch **mode** and **Day/Night** switchover. By setting of choice mode of **2 number groups** the DoorPhone is permanently in **DAY** mode.  
By password choice some rules have to be observed:
- Select passwords in way not to find its combination out from wear of certain buttons by frequent use.
  - Select the first password button from frequentless button for direct dialing (-extends choice time)(-not valid for keyboard).
  - Pay attention to congruity of password numbers when one password includes other one, e.g. relay 1 has 1234 and relay 2 has 12345. Then after pressing button 4 the only relay 1 is called, but password choice 234 for relay 2 can call both relays after pressing switch 4.
- 3 –Command from phone after relay closing [2 digits]. The same command can be set for both relays, then they are activated at the same time. The advantage is to set the same command both for relay closing and command to DoorPhone hanging up (page 23).
- 4 –Duration of relay closing in second [2 digits 01-99]
- 5 –To prohibit the control during incoming call is important e.g. when using relay 2 in mode 1 for control of garage gate opening, when the electronics opens the gate and the gate is closed by car passage. Then the control from phone could undesirably cause the permanent gate opening (not closed – no car passage).
- 6 –time in second between close relays 1 and 2 by mode setting of relay 2 is **5** (gradual opening) [2 digits 01-99]
- 7 –Default value – presets to the firm settings. After making changes use the save changes button.

### 3.2.3 Time Parameters

Day mode

**Menu:**

- Network setting
- Basic parameters
- Setting audio
- Setting video
- Relays
- Time parameters ✓
- Memory numbers
- Service
- Video

Language:

english

**Time parameters:**

Maximum call duration [min]:  ①

Numbers of rings:  ②

Time between key presses [sec]:  ③

Time hang up before redial [sec]:  ④

Time before redial [sec]:  ⑤

Audio signaling - opening/closing:  ⑥

Audio signaling - others tones:  ⑦

⑧

After making changes use the **save changes** button.

- 1 –max. time, for which the DoorPhone is hanging up, this time can be extended during call by sign choice from telephone (\* or #) – see page 23.
- 2 –Number of incoming call rings, the DoorPhone pick up after presetted number of rings. After detection first ring – LED on front panel blinking. The number can be set from 1 to 9.
- 3 –max. time [sec] among button presses [range 1-9]
  - normal buttons
    - **switch closing** – if time between two next presses is bigger than **w** time, the code is not evaluated correctly.
    - **dialing** – if the button, we are pressing, is the first password number for switch closing, so the choice is delayed by this **w** time.
  - keyboard
    - **switch closing** – if time between two next presses is bigger than **w** time, the code is not evaluated correctly.
      - dialing the same as of phone, if time after the last pressed button is bigger than **w** time, then the dialing starts. If the number is incomplete, it is necessary to hang up (**X** button) and the dialing will be repeated.
      - dialing from memory, if time following the first pressed button is longer than **w** time, then the entry of memory number has to be repeated.
- 4 –time [sec] for which the guard will hang up, before repeated dialing (button pressing during call or dialing, busy tone detection) [range 1-5]
- 5 –after finishing the dialing it calculates time (ringing tones). If the number exceeds time in second, it will hang up [range 10-99]. The dialing is repeated in case, when the dialing mode of 2 groups is set.
- 6 –In default is status of DoorPhone signalling acoustically. If signalling makes problem, so this signalling pick up / hang up prohibited.

- 7 –In default is status of DoorPhone signalling acoustically. If signalling makes problem, so this signalling others tones prohibited.
- 8 –Default value – presetsings to the firm settings. After making changes use the save changes button.

### 3.2.4 Direct Dialing – Memories

Day mode
**Memory numbers:**

**Menu:**

- Network setting
- Basic parameters
- Setting audio
- Setting video
- Relays
- Time parameters
- Memory numbers ✓
- Service
- Video

Language:

english

Group DAY <span style="float: right;">①</span>	Group NIGHT <span style="float: right;">②</span>
Button 1: <input type="text" value="192*168*1*230"/>	Button 1: <input type="text"/>
Button 2: <input type="text" value="192*168*1*231"/>	Button 2: <input type="text"/>
Button 3: <input type="text"/>	Button 3: <input type="text"/>
Button 4: <input type="text"/>	Button 4: <input type="text"/>
Button 5: <input type="text"/>	Button 5: <input type="text"/>
Button 6: <input type="text"/>	Button 6: <input type="text"/>
Button 7: <input type="text"/>	Button 7: <input type="text"/>
Button 8: <input type="text"/>	Button 8: <input type="text"/>
Button 9: <input type="text"/>	Button 9: <input type="text"/>
Button 10: <input type="text"/>	Button 10: <input type="text"/>
Button 11: <input type="text"/>	Button 11: <input type="text"/>
Button 58: <input type="text"/>	Button 58: <input type="text"/>
Button 59: <input type="text"/>	Button 59: <input type="text"/>
Button 60: <input type="text"/>	Button 60: <input type="text"/>
Button 61: <input type="text"/>	Button 61: <input type="text"/>
Button 62: <input type="text"/>	Button 62: <input type="text"/>
Button 63: <input type="text"/>	Button 63: <input type="text"/>
Button 64: <input type="text"/>	Button 64: <input type="text"/>

③

After making changes use the **save changes** button.

- 1 –telephone number up to 16 digits, we want to store. The numbers are the numbers of the **first group** or numbers of **Day** mode. In default setting is table memoirs empty. While using setting P2P to the memoirs saves IP address e.g . 192\*168\*1\*250, where „\*“ means „.“ , while using SIP proxy server to the memoirs saves phone number e.g . 117.
- 2 –telephone number up to 16 digits, we want to store. The numbers are the numbers of the **second group** or numbers of **Night** mode. In default setting is table memoirs empty. While using setting P2P to the memoirs saves IP address e.g . 192\*168\*1\*250, where „\*“ means „.“ , while using SIP proxy server to the memoirs saves phone number e.g . 117.

**Note:** The switchover to Day/Night mode remains set in DoorPhone even after power supply disconnection.

- 3 –Default value – presetsings to the firm settings. After making changes use the save changes button.

IPDP - installation and operating instructions 27

## 4 Technical Parameters

### 4.1 Electrical Parameters

Parameter	Value	Conditions
Communication interface	Ethernet 10BaseT, 100BaseTx	
VoIP protocol supported	SIP	
Band width	300Hz – 3400 Hz	
Power supply of lighting through, switches and heating	12Vss ± 2V , 10-12Vst ± 2V	
Max. consumption	300mA	12Vss
Max. voltage of switch contact	48V	at I < 1A
Max. current of switch contact	2A	at U < 30 V
Operational temperature	- 20 to + 50°C	

### 4.2 Mechanical dimensions

Type of item	dimensions HxWxD [mm]			
	1 module	2 modules	3 modules	4 modules
MKxx mount. box	114x118x45	204x118x45	294x118x45	384x118x45
KPDxx (on plast.)1col.	151x157x79	241x157x79	331x157x79	421x157x79
KPDxx (on plast.)2col.	-	241x286x79	-	421x286x79
Canopy xx	149x151x49	241x151x49	331x151x49	421x151x49
Fixing frame	147x151x3	239x151x3	299x151x3	399x151x3

**Guarantee conditions:**

The product was shop-checked. The producer guarantees that this product will keep the features described in these operating instructions in the course of guarantee provided that the user will be handled with it as described in the operating manual. The guarantee will be extended by period of possible guarantee repair.

When claiming in guarantee period please contact your dealer. The producer only will make the guarantee repairs. Attach the description of claim reason, proof of purchase and your exact address to the product.

**The guarantee does not include:**

- mechanical, thermal, chemical and other damages caused by user's activities
- defects caused by natural disasters
- defects caused by repair or changes carried out by user or other unauthorized person
- willful damage of product
- incorrect use of product caused by other use than specified in operating manual (e.g. installation, programming)
- damages caused during product transport to customer and from supplier

Producer:
Dealer:
Date of sale:

© JR 2008 version V1.0 IX/08



Тел: +7 495 7907870  
Моб: +7 965 4429948  
Skype: Discoverytelecom  
Mail: [info@discoverytelecom.ru](mailto:info@discoverytelecom.ru)  
[www.discoverytelecom.ru](http://www.discoverytelecom.ru)